

**RUSETTI  
ROSETT I SATIN  
SATIN BOW TIE  
SATIJNEN STRIKJE  
SATINFLIEGE**

OTTOBRE design® 6/2009  
(Print for free)

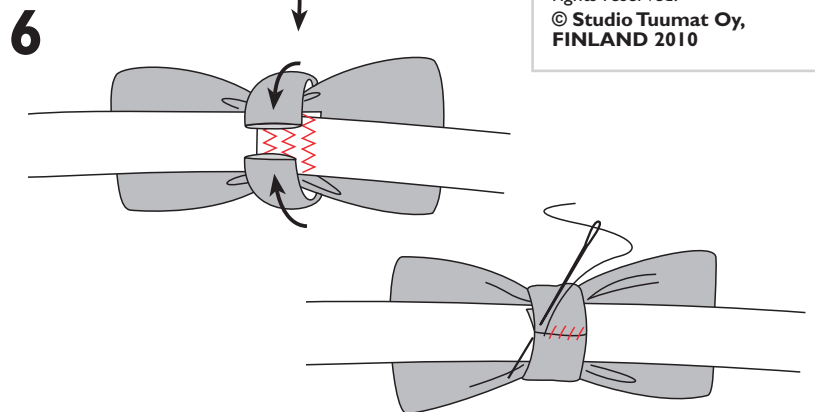
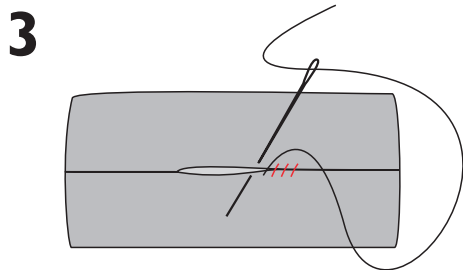
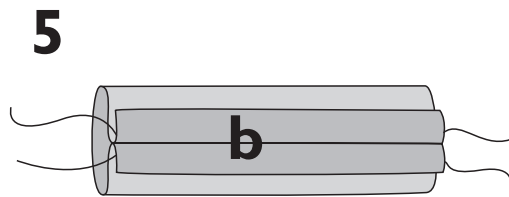
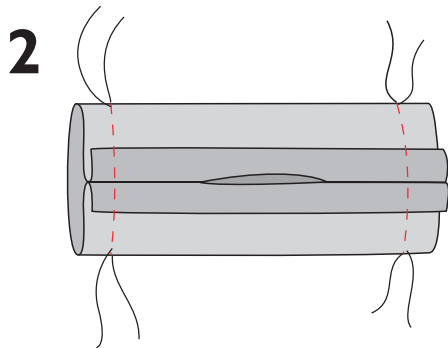
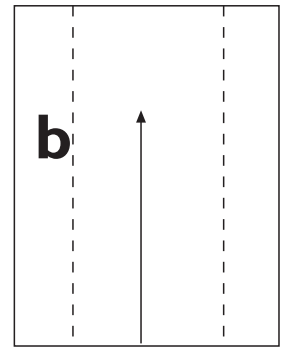
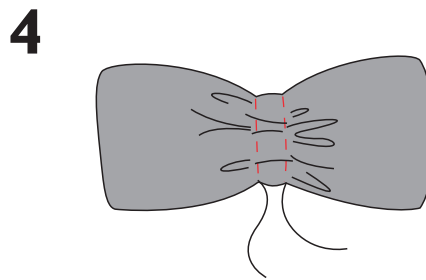
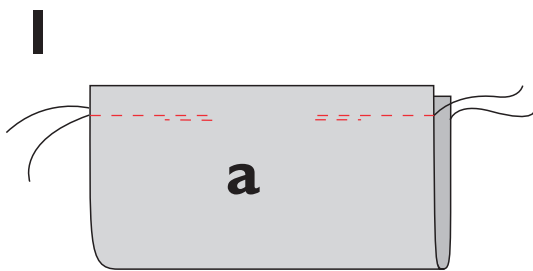
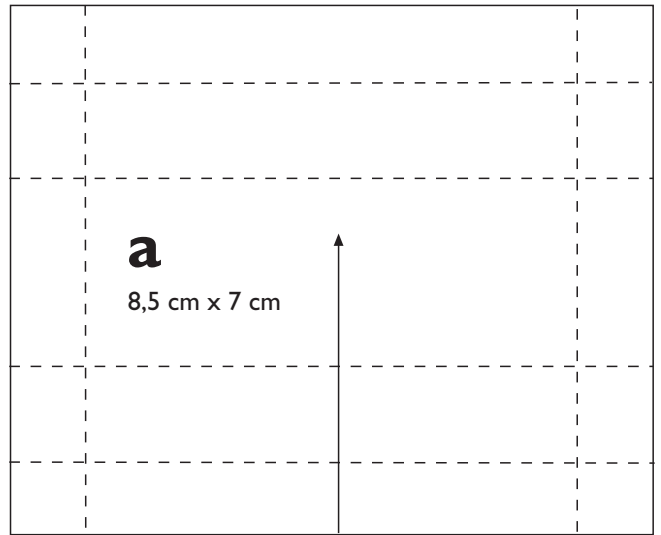

The designs, instructions and patterns are only intended for personal use by sewing hobbyists. All commercial or industrial use is prohibited. The designs, instructions, patterns, drawings and photos are protected by copyright laws and the right of reproducing them by any means or in any form is exclusively reserved for the copyright holder. The transferring of the material to a device that can be used for copying it is also regarded as reproduction. All rights reserved.  
© Studio Tuumat Oy, FINLAND 2010

**OTTOBRE**